

UPS Pico

Uninterruptible **P**ower **S**upply
with **P**eripherals and **I²C** control Interface

for use with

Raspberry Pi[®] B+, A+, B, and A

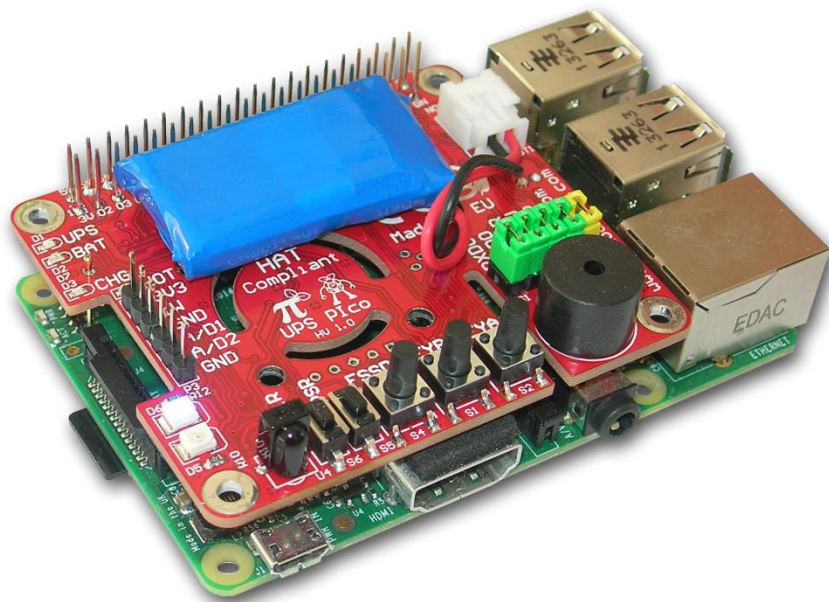

HAT Compliant

“Raspberry Pi” is a trademark of the Raspberry Pi[®] Foundation

© PiModules & ModMyPi

Intelligent Modules for your Raspberry Pi[®]

Designed and Manufactured by PiModules and ModMyPi

www.pimodules.com

www.modmypi.com

System Overview

Introduction

The **UPS Pico** is an advanced uninterruptible power supply for the Raspberry Pi® that adds a wealth of innovative power back-up functionality and development features to the innovative microcomputer!

The standard **UPS Pico** is equipped with a 300mAh LiPO battery specially designed to enable safe shutdown during a power cut. Additionally, this can be easily upgraded to the extended 3000mAh version, which enables prolonged use of a Raspberry Pi for **up to 8 hours** without a power supply connected!

The **UPS Pico** features an embedded measurement system that continuously checks the powering voltage of the Raspberry Pi®. When the cable power on the Raspberry Pi® is absent, insufficient, or the device detects a power failure, the **UPS Pico** automatically switches to the unit's battery source. The module then continues to check the voltage on the Pi and switches automatically back to the regular cable supply when power is once again available.

The **UPS Pico** is powered and the battery pack intelligently charged via the GPIO pins on the Raspberry Pi®, so no additional cabling or power supply is required.

The **UPS Pico** is designed to be 100% compliant with [HAT standards](#) for the Raspberry Pi® B+ and A+, and is mechanically compatible with the original Raspberry Pi® models A and B when an extension header is used. In addition to this, because the **UPS Pico** requires no external powering and fits within the footprint of the Raspberry Pi®, it is compatible with most cases.

The **UPS Pico** can also be equipped with an optional **Infra-Red Receiver** which is routed directly to GPIO18 via the PCB. This opens the door for remote operation of the Raspberry Pi® and **UPS Pico**!

Finally, the **UPS Pico** features an implemented Automatic Temperature Control **PWM FAN controller**, and can be equipped with a micro fan kit, which enables the use of the Raspberry Pi® in extreme conditions including very high temperature environments.

Applications

UPS Pico is equipped with plenty of features which make it an extremely useful tool for Raspberry Pi® project development. It not only provides powering continuity, but also offers extra user programmable LEDs, Sensors, buttons and I/O's. The unit also features a dedicated **10-bit analogue to digital converter** with two channels making it the perfect board for remote and unmanned sensor deployment. These extra features result in the **UPS Pico** being a superior all-in-one device perfect for many innovative projects, and embedded applications.

Features

The list of features of the **UPS Pico** is as follows:

- Raspberry Pi B+ **HAT Compliant**
- **Plug and Play**
- **Smart Uninterruptible Power Supply (UPS)**
- **Integrated LiPO Battery** (8-10 Minutes of Power Back-Up)
- **Intelligent Automatic Charger**
- **No Additional External Power Required**
- **Additional 3000 mAh** Battery for 8 Hours Run-Time (Not Included)
- **5V 2A Power Backup (Peak Output 5V 3A)**
- Integrated Software Simulated **Real Time Clock (RTC)** with Battery Back-Up
- **File Safe Shutdown** Functionality
- Raspberry Pi B+ **Activity Pin**
- **PWM FAN control** (Fan Not Included)
- **2 User Defined LEDs**
- **2 User Defined Buttons**
- **Integrated Buzzer** for UPS and User Applications
- **Status Monitoring** - Powering Voltage, UPS Battery Voltage and Temperature
- **I2C PICO Interface** for Control and Monitoring
- **RS232 Raspberry Pi** Interface for Control and Monitoring
- **XTEA Based** Cryptography User Software Protection
- 2 Level **Watch-dog Functionality** with **FSSD and Hardware Reset**
- **Raspberry Pi B+ Hardware Reset Button via Spring Test Pin** (Not Included)
- **Jumpers for Raspberry Pi B+ Pin** Functionality Selection
- **Stackable Header** for Add-On Boards
- **Boot Loader** for Live Firmware Update
- Compatible with **Intelligent IR Remote Power ON/OFF (PowerMyPi)**
- **Integrated ESD-Protected 2 Channel A/D 10 Bit Converters 0-5.2V**
- **Integrated ESD-Protected 1-Wire Interface**
- **Labeled J8 Raspberry Pi B+ GPIO Pins** for Easy Plug & Play
- **Infra Red Receiver** Sensor Interface (IR Not Included)
- **Upgradable with Pico Add-on Boards**
- **Fits Inside Most Existing Cases**

Hardware Upgrades – the Pico Add-on Boards

The **UPS Pico** is equipped with plenty of features that make it an extremely useful tool for Raspberry Pi® based project development. However, it can't do everything! In order to cover a broader range of user requirements, we are developing a wide range of add-on boards that can be hosted on the top of **UPS Pico**. These **Pico Add-on Boards** will be designed to extend the functionality of the product, whilst being simple to integrate by plugging directly on top! However, in order to keep compatibility with **HAT standard**, each **Pico Add-on Boards** data will be stored in the **UPS Pico HAT EEPROM**. The following upgrade boards are in development and will be available soon:

- **EPR Pico Board**

The **Extended Powering Pico Board**, will be designed to accept external powering voltage from 6 - 32V DC, and enable the use of solar panels. The device will also be equipped with various sensors, an RS232 converter, a USB interface, a bi-stable Relay and many more useful I/O's. The **EPR** will of course retain the powering functionality of the **UPS Pico**.

- **MCOM Pico Board**

A **Multi-Communication Pico Board**, offering a multiple communication channels including 4 x RS232, RS485, etc.

- **RBT Pico Board**

A **RoBoT Pico Board**, offering a toolset for the ROBOT projects development.

- **SNS Pico Board**

A **SeNsorS Pico Board**, offering a toolset for various sensors projects development.

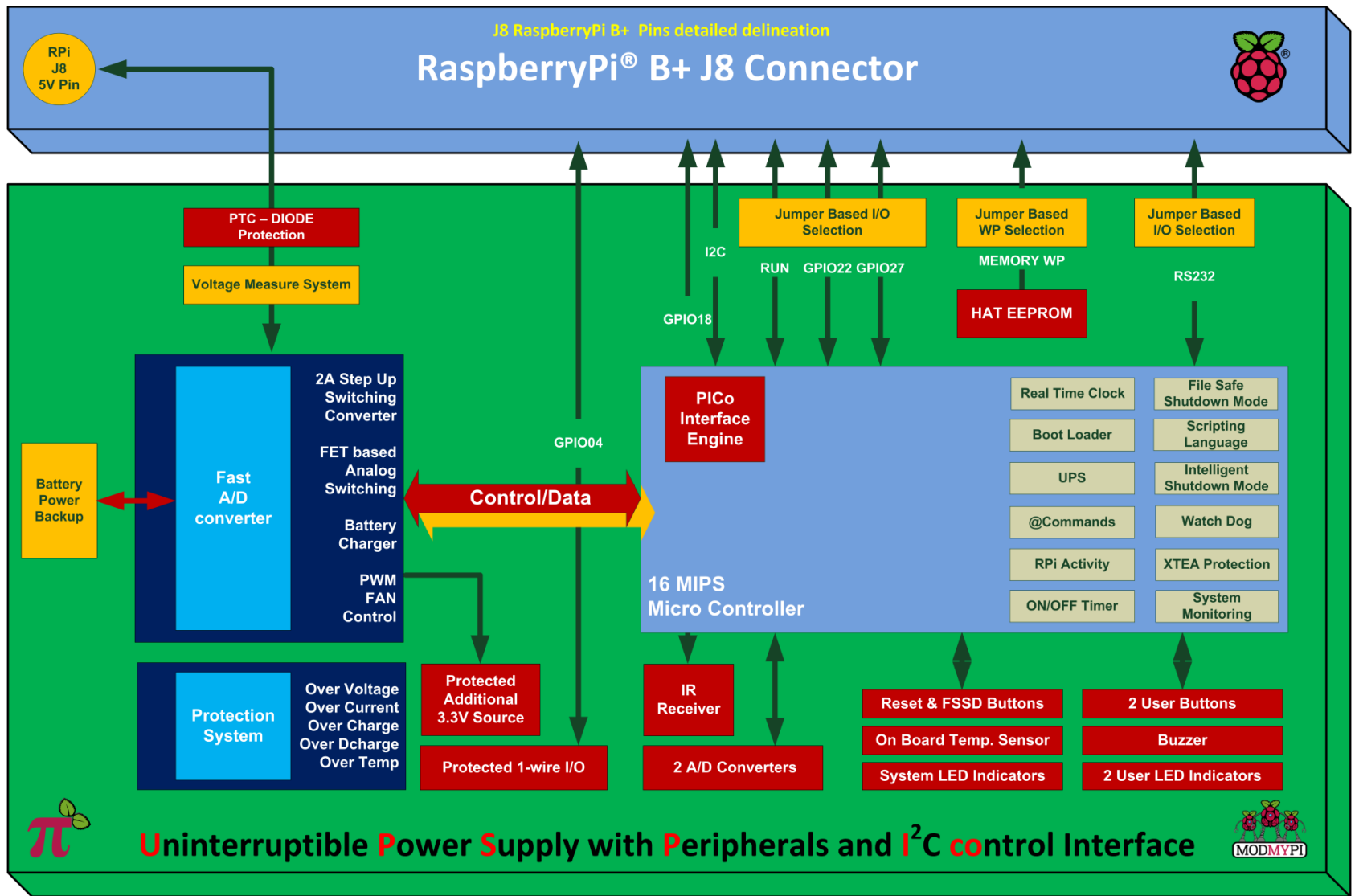

Designed and Manufactured by PiModules and ModMyPi

www.pimodules.com

www.modmypi.com

Photo Gallery

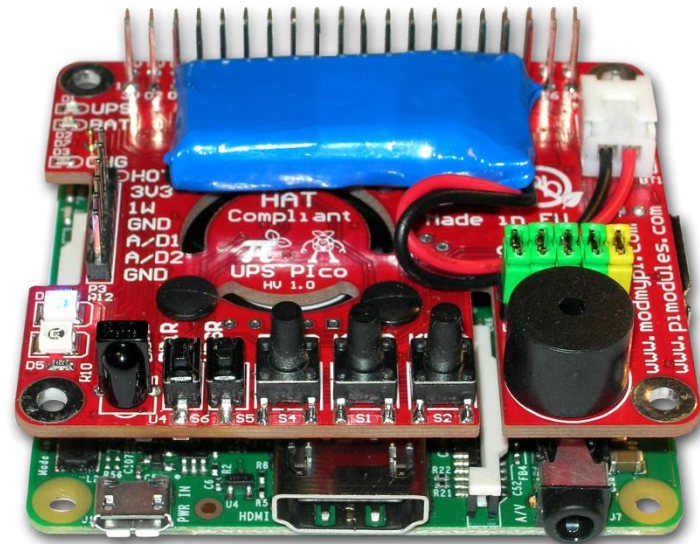
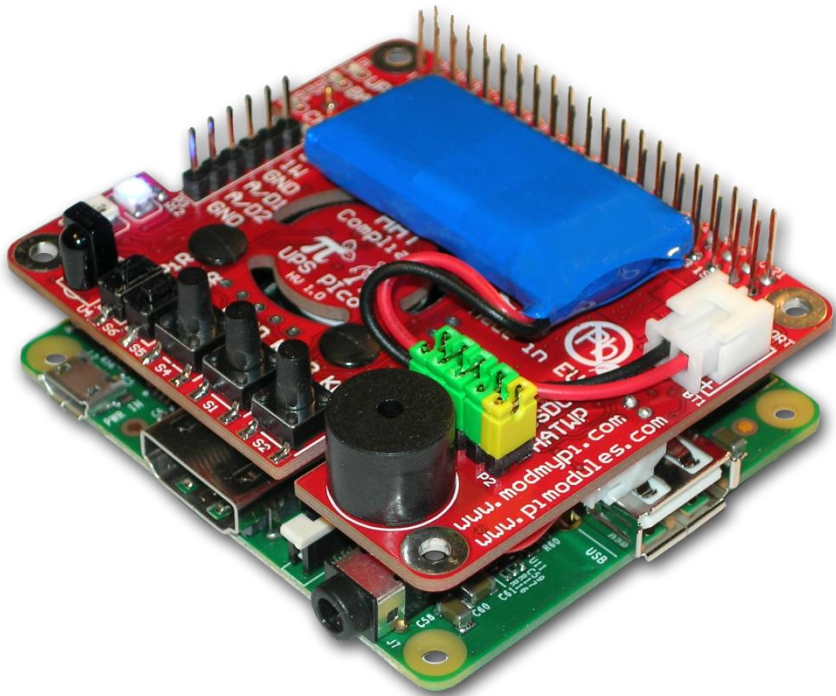

Designed and Manufactured by PiModules and ModMyPi
www.pimodules.com www.modmypi.com

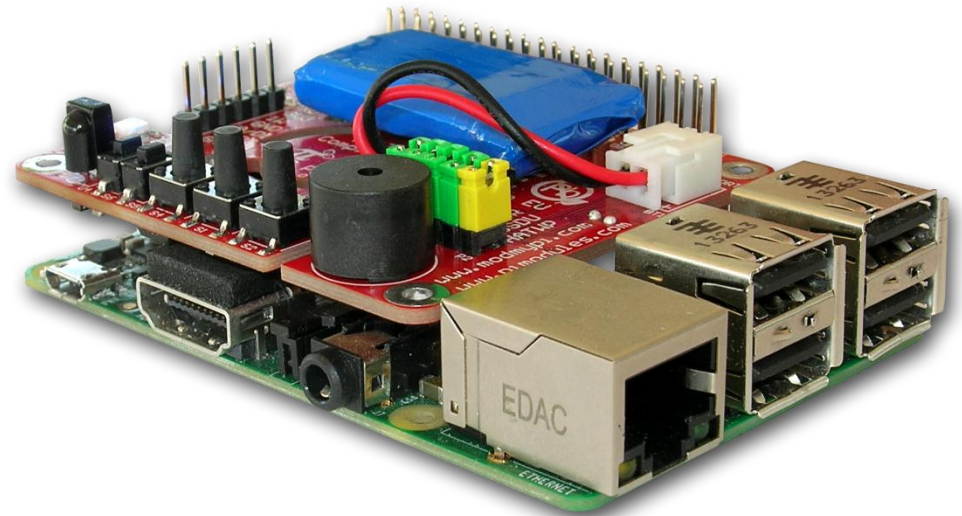
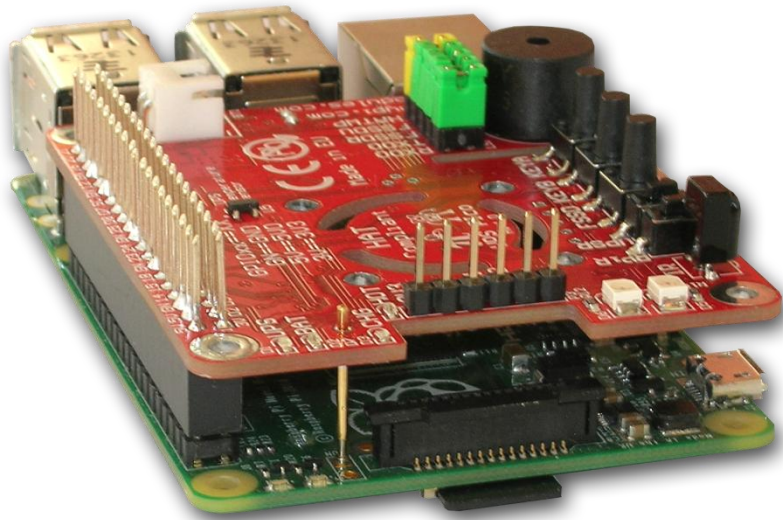

Designed and Manufactured by PiModules and ModMyPi
www.pimodules.com www.modmypi.com

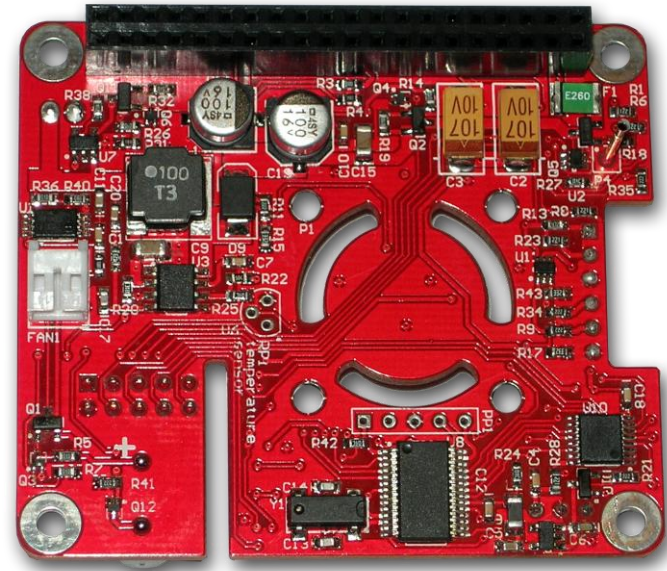
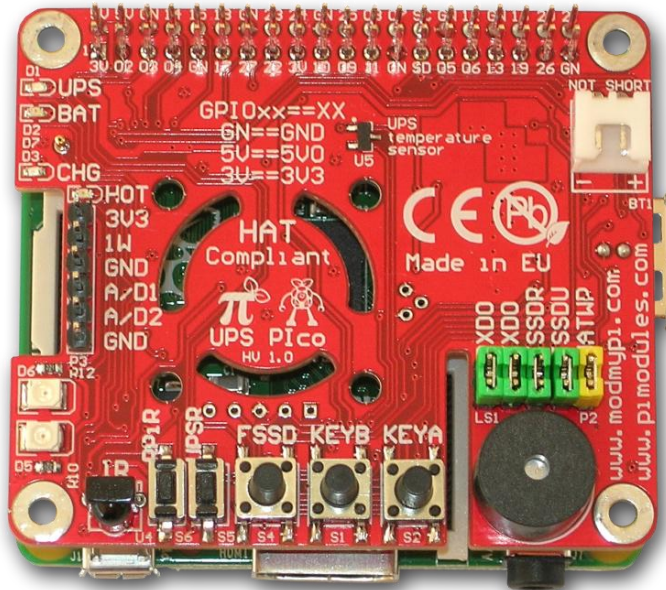

Designed and Manufactured by PiModules and ModMyPi
www.pimodules.com www.modmypi.com

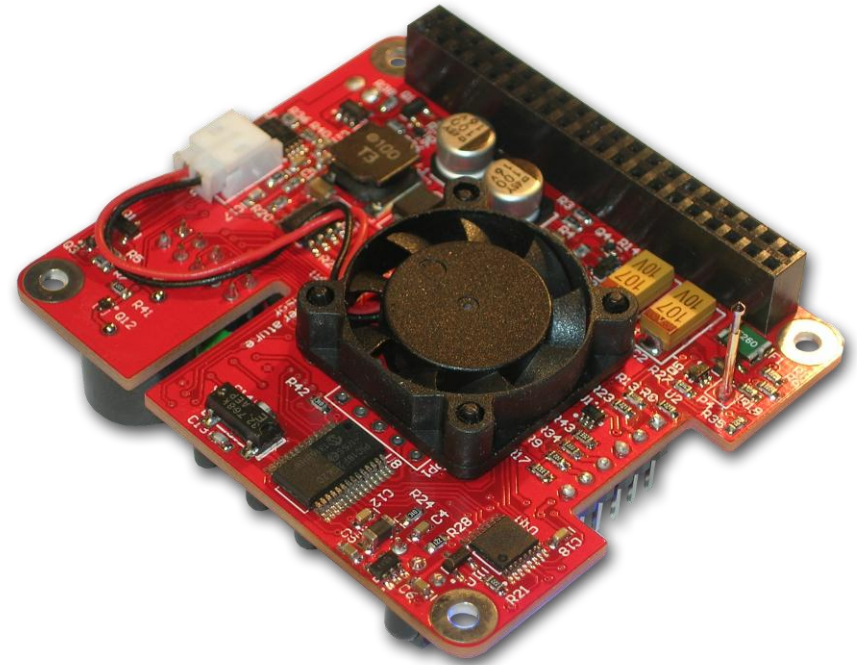

Designed and Manufactured by PiModules and ModMyPi
www.pimodules.com www.modmypi.com